

h=15

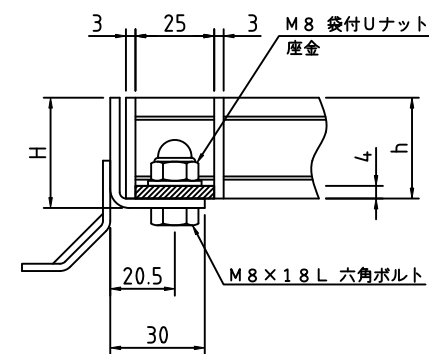

h=20 以上

ボルト固定部詳細

記事

1. 桁穴 : 250×250用
(15mmピッチ)
2. タイプ : IB, ザラザラタイプ
3. 材質 : SUS304

グレーチング			受 枠		荷重条件
型 式	メインバー 高さ(h)	クロスバー 材料	型 式	寸法 H	横断
S4IRV30-1515	15	FB3×10	B-15	18	T2
S4IRV30-2015	20	FB3×10	B-20	23	T14
S4IRV30-2515	25	FB3×15	B-25	28	T20

APPROVED BY		WORK NO.
JUDGED BY		
ENG' R IN CHARGE		
CHECKED BY		
DRAWN BY		
DATE DRAWN		DRAWING NO.
SCALE		DAIKURE CO., LTD.