

メインバー詳細

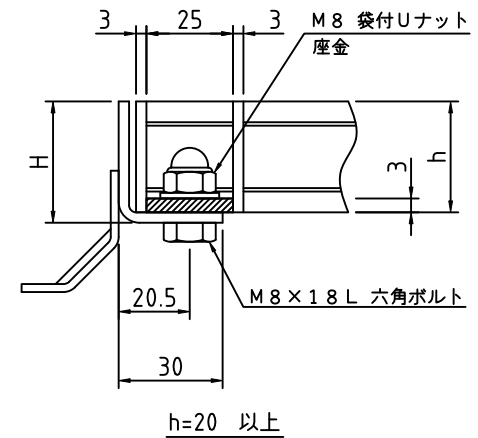
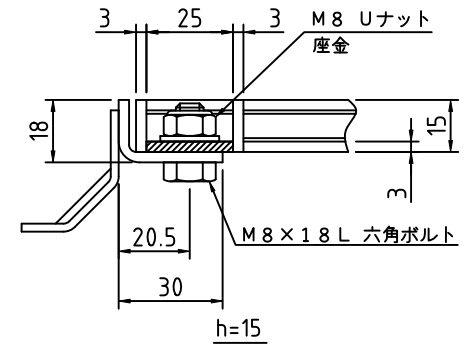

ボルト固定部詳細

記事

1. 溝幅 : 150用 (10mmピッチ)
2. タイプ : FB4t, NSタイプ
3. 材質 : SUS304

グレーチング			受 枠		荷重条件	
型 式	メインバー 高さ (h)	クロスバー 材料	型 式	寸法 H	横断	側溝
S4FXC20-1510	15	FB3×10	BB-15	18	T14	T20
S4FXC20-2010	20	FB3×10	BB-20	23	T20	T20
S4FXC20-2510	25	FB3×15	BB-25	28	T20	T20
S4FXC20-3210	32	FB3×15	BB-32	35	T20	T20

APPROVED BY		WORK NO.
JUDGED BY		
ENG' R IN CHARGE		
CHECKED BY		
DRAWN BY		
DATE DRAWN		DRAWING NO.
SCALE		DAIKURE CO., LTD.