

水抜孔詳細 (Aタイプ) (S=1/2)

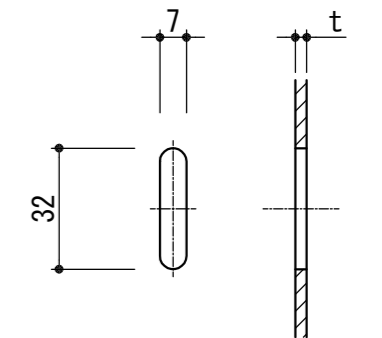

水抜孔詳細 (Bタイプ) (S=1/2)

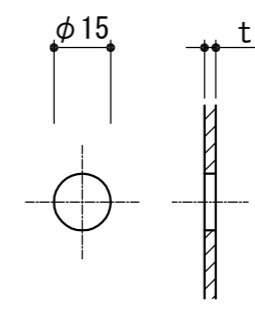

水抜孔詳細 (Eタイプ) (S=1/2)

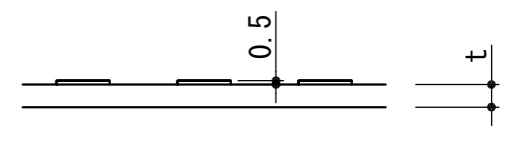

蓋詳細 (S=1/1)

ピット用溝蓋(プレート)					荷重条件
型 式	板厚 t	ピッチ			横断
		P1	P2	P3	
NPW-A-20	3t	60	60	39.5	人
	4t				
NPW-B-20	3t	60	60	39.5	人
	4t				
NPW-E-20	3t	60	60	39.5	人
	4t				

- 記事
- タイプ : ポルキープレートタイプ
  - 材質 : SUS304

APPROVED BY		WORK NO.
JUDGED BY		
ENG'R IN CHARGE		DRAWING NO.
CHECKED BY		
DRAWN BY		
DATE DRAWN		
SCALE	1/6	DAIKURE CO., LTD.