

水抜孔詳細 (Aタイプ) (S=1/2)

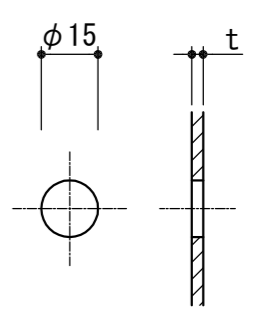

水抜孔詳細 (Eタイプ) (S=1/2)

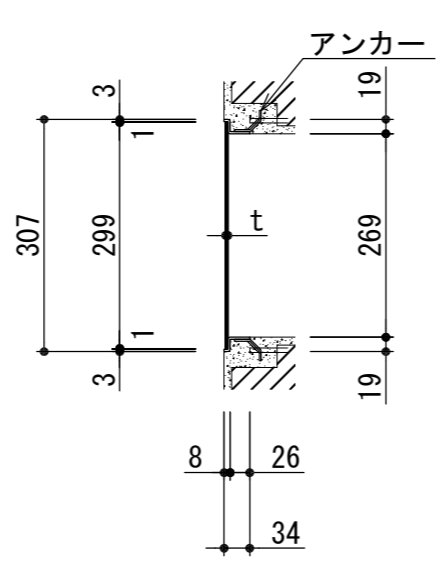
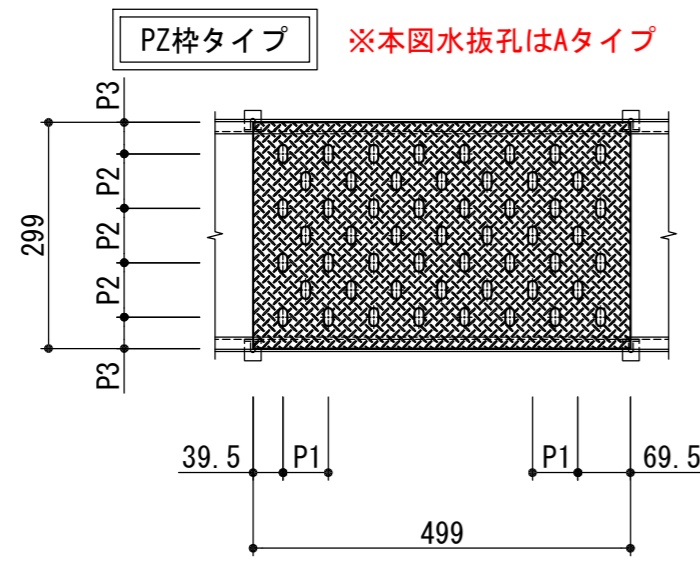
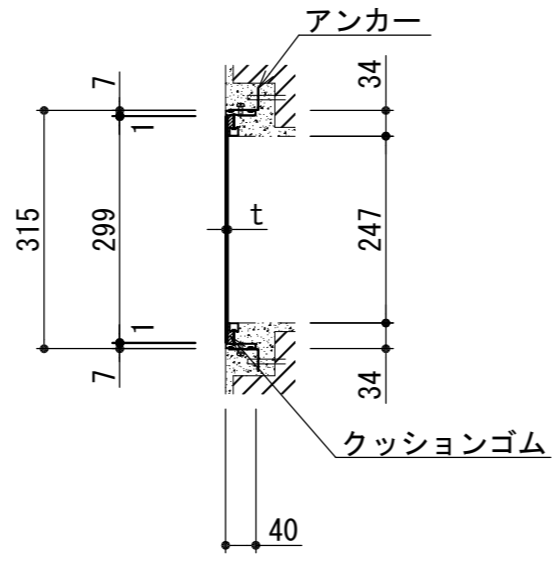
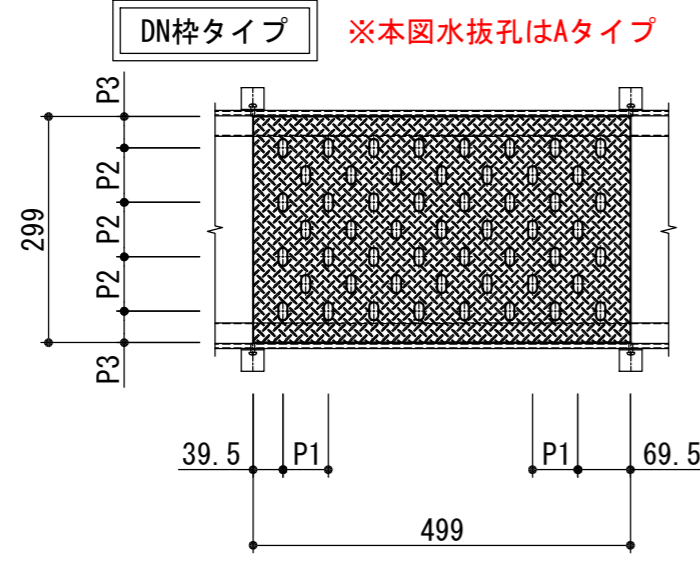

ピット用溝蓋(プレート)					荷重条件
型 式	板厚 t	ピッチ			
		P1	P2	P3	
NPK-A-30	3.5t	60	72	41.5	人
	4.5t				
NPK-E-30	3.5t	60	72	41.5	人
	4.5t				

- 記事
- タイプ : チェッカー/凸プレートタイプ
 - 材質 : SUS304

APPROVED BY		WORK NO.
JUDGED BY		
ENG'R IN CHARGE		DRAWING NO.
CHECKED BY		
DRAWN BY		
DATE DRAWN		
SCALE	1/10	DAIKURE CO., LTD.